

This equipment has been tested and found to comply with the limits for Industrial, Scientific, and Medical Equipment (ISM), pursuant to Part 18 of the FCC Rules. These limits are designed to provide reasonable protection against harmful interference in a residential installation. This equipment generates, uses, and can radiate radio frequency energy, and if not installed and used in accordance with the instructions, may cause harmful interference to radio communications. However, there is no guarantee that interference will not occur in a particular installation. If this equipment does cause harmful interference to radio or television, which can be determined by turning the equipment off and on, the user is encouraged to try to correct the interference by one or more of the following measures:

Reorient or relocate the receiving antenna.

Increase the separation between the equipment and receiver.

Connect the equipment into an outlet on a circuit different from that to which the receiver is connected.

Consult the Distributor or an experienced radio/TV technician for help.

FCC DECLARATION OF CONFORMITY

Name: activTek Environmental

Model: activTek INDUCT 2000

Manufacturer: activTek Environmental

This device complies with Part 18 of the FCC Rules.

RESPONSIBLE PARTY

activTek Environmental
310 T. Elmer Cox Dr.
Greeneville, TN 37743

Ph: (888)664-1812

Signature: _____

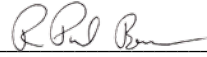

Printed Name: R. Paul Beam

Title: Engineering Manager

Date: 7/9/04

activTek 
ENVIRONMENTAL

www.ecoquest.company

310 T. Elmer Cox Drive
Greeneville, TN 37743
(888)664-1812

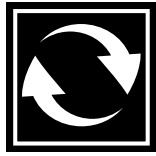

activTek **INDUCT 2000**

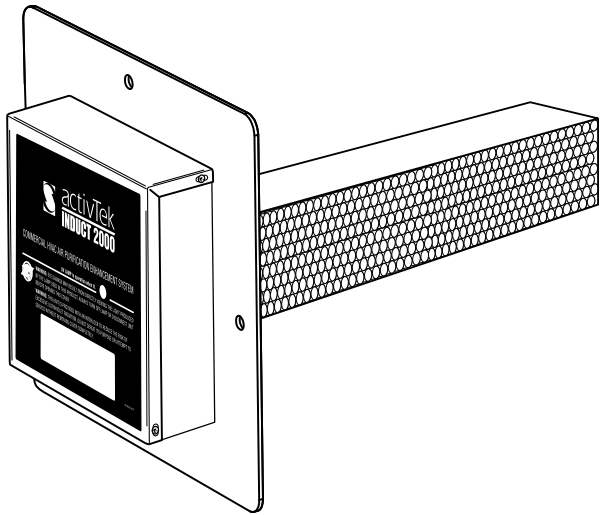

OWNER'S MANUAL

- Specifications
- Installation
- Operation
- Features
- Maintenance

CAUTION: Read manual carefully for proper procedures and operation.

CONGRATULATIONS ...

on your purchase of an activTek INDUCT 2000 air purification enhancement system. This unit is designed to be installed into an existing HVAC system, and used as a virtually maintenance free enhancement to activTek air purification technology. Please read and follow all service procedures outlined in this manual. Use only genuine activTek replacement parts available from your activTek Distributor.

If you have any questions concerning this or any activTek product, contact your activTek Distributor.

Please record the name and phone of your activTek Distributor:

Name _____

Phone _____

Please record the serial number of your activTek INDUCT 2000:

Serial # _____

CONTENTS

Product Contents	3
Installation Hardware	3
Replacement Parts	3
Specifications	4
About activTek INDUCT 2000	4
Recommended Installation Tools	5
Installation Requirements	5
Metal Ductwork Installation	6
Fiberglass Ductwork Installation	8
Maintenance/UV Lamp Indicator	10
Disposal of the ActivePure Cell	10
Warranty	10
Changing the ActivePure Cell	11

This owner's manual is also available online at: <http://www.activTek.net>.

PRODUCT CONTENTS

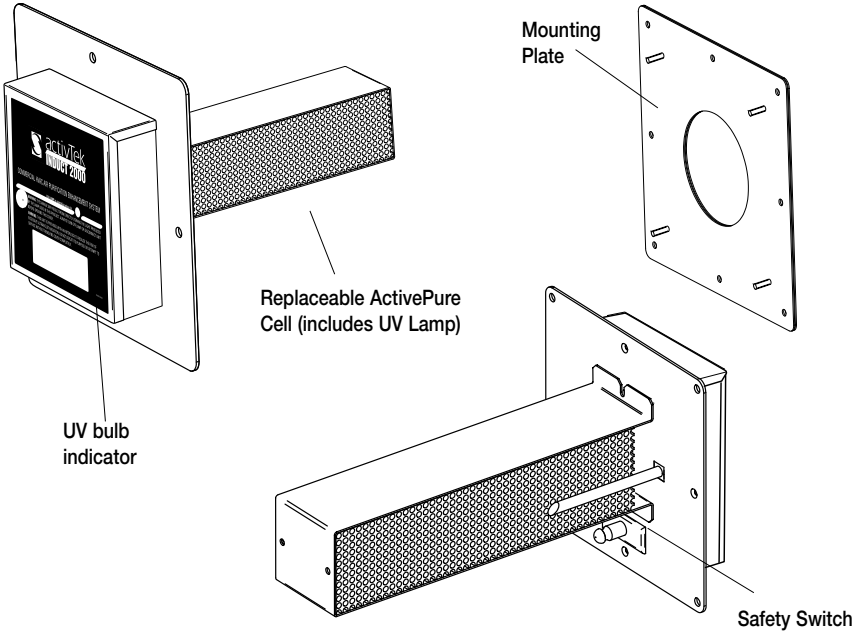

INSTALLATION HARDWARE



(8) #8 - .75
1/4" Self-tapping screws
Item # US70679



(4) #6 - 32 X 2 inch
Threaded bolts
Item #US70680



(4) #8 - 32
Hex nuts
Item # US70681

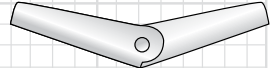

(4) #6 - 32
Toggle bolt wall anchors
Item # US70682

REPLACEMENT PARTS

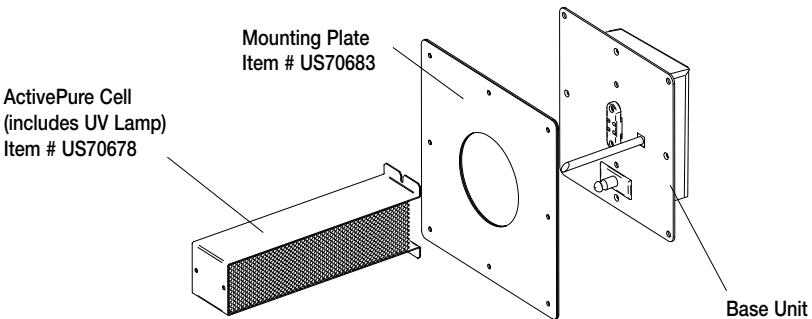

Features:

- Low level O₃ production: 0.04 ppm maximum.
- Replaceable ActivePure Cell.

Electrical:

- 120/220 V~ 60 HZ or 100/240 V~ 50/60 HZ depending on model.
- 15 watts power consumption.

Mechanical:

- Distribution via air handler.

Size:

- Dimensions: 6" x 6" x 11.25" (15 cm x 15 cm x 28.5 cm.)
- Weight: 3 pounds (1.2 kg.)

Coverage:

- Covers up to 2000 ft² (186 m²).

Warranty:

- Length of warranty will vary depending on model.
See warranty card for specific details.

ABOUT ACTIVTEK INDUCT 2000

activTek INDUCT 2000 is a new generation HVAC Air System designed to reduce odors, smoke, and a broad spectrum of indoor air contaminants.

activTek INDUCT 2000 is easily mounted into air conditioning and heating system air ducts where many problems can start. When the HVAC system is in operation, activTek INDUCT 2000 creates an Advanced Oxidation Process consisting of hydroperoxides, superoxide ions, and safe low level ozone - all friendly oxidizers that revert back to oxygen and hydrogen after the oxidation of a pollutant.

Used in conjunction with other activTek air purification systems, activTek INDUCT 2000 can boost effectiveness and help distribute their benefits throughout your home.



WARNING! - UV Light in operation. Disconnect unit from power supply before servicing. Failure to follow warnings may result in severe eye damage.



Location for Protective Earth Line.



WARNING! - This unit must be installed by a licensed HVAC contractor. Failure to do so will void warranty of the product.



WARNING! - This unit utilizes a switchable ballast and is factory set for 220V applications. If used in 120V application the cover must be removed and the ballast switched to 120VAC.

RECOMMENDED INSTALLATION TOOLS

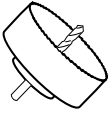

3 1/2" Hole Saw
for wood or metal
(recommended)

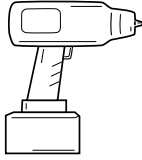

Drill/Power Driver



Phillips Screwdriver



3/8" Drill Bit
(if installing into fiberglass
ducting with toggle bolts)



11/32" Open-End Wrench

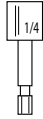

1/4" Nut Driver Bit

You may also need:



Utility Knife

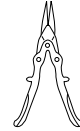

Tin Snips
(for metal ductwork)

INSTALLATION REQUIREMENTS

Installation Requirements

1. Unit should be installed after the air handler in the HVAC system.
2. The duct work around the installation area should be clean and dry to insure proper adhesion of the gasket materials and any tape used.
3. An approximate 3.5" (8.89 cm) opening will need to be cut into the existing duct work to install the unit properly.

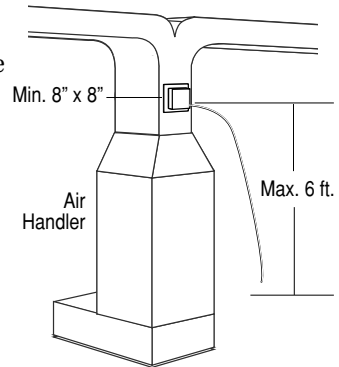

Electrical Requirements for 120 volt installation only

- To use a 120 volt plug, be sure to locate the unit within 6 ft. of a standard 120 volt grounded outlet. Long term use of an extension cord is not recommended due to safety considerations.
- Install a US "B" UA approved plug onto the blunt cord.

Hardwiring Requirements (All units)



- **Permanent wiring of the unit into your HVAC system, or installations using a 120/220 volt, should be done by a licensed HVAC installer or electrical contractor only.**

WARNING: CHECK SPECIFICATIONS ON LABELING BEFORE INSTALLING.

UNIT IS EITHER: 120V, 220V, or DEPENDING ON MODEL 100-240V.

For 110 volt units: Black = L1, White = Neutral, Green = Ground

For 220 volt units: Black = L1, White = L2, Green = Ground

For International Units: Brown = L1, Blue = L2, Green w/yellow stripe = Ground

METAL DUCTWORK INSTALLATION

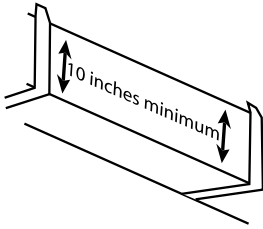

1. Locate suitable area of duct for installation.

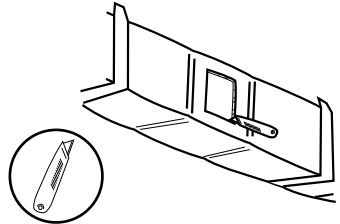

2. Cut away insulation to expose metal duct (if needed).

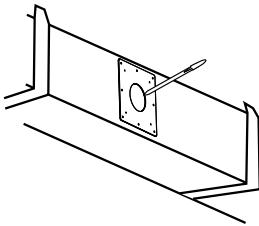

3. Mark location for 3.5" opening using either the mounting plate or included template.

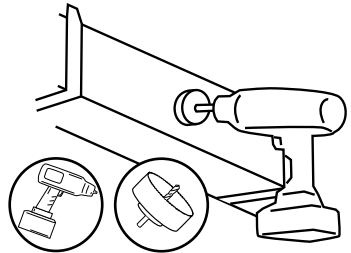

4. Cut hole in duct using 3.5" hole saw.

ALTERNATIVE CUTTING METHOD

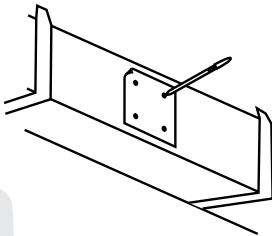

a. Using template, mark 4 holes on duct.

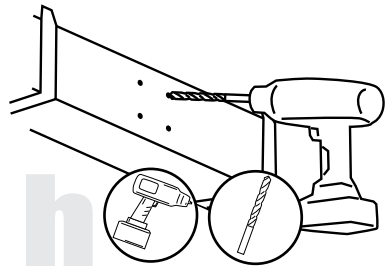

b. Drill 4 holes where marked.

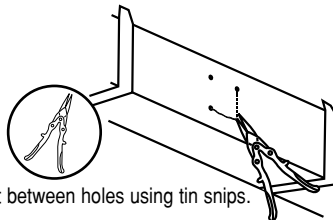

c. Cut between holes using tin snips.

activTek INDUCT 2000 - CELL HOLE PLACEMENT TEMPLATE

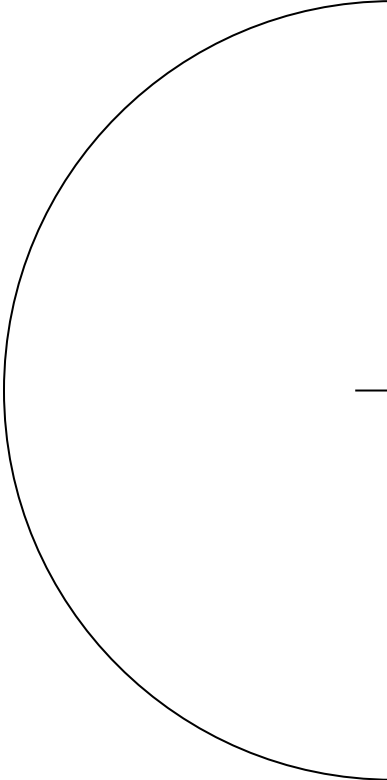
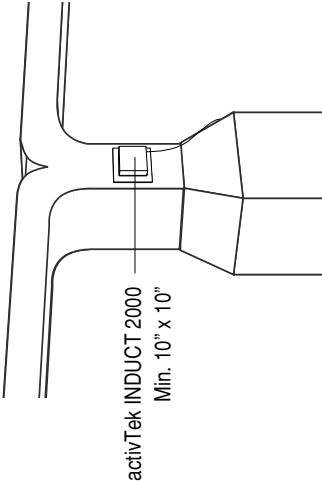

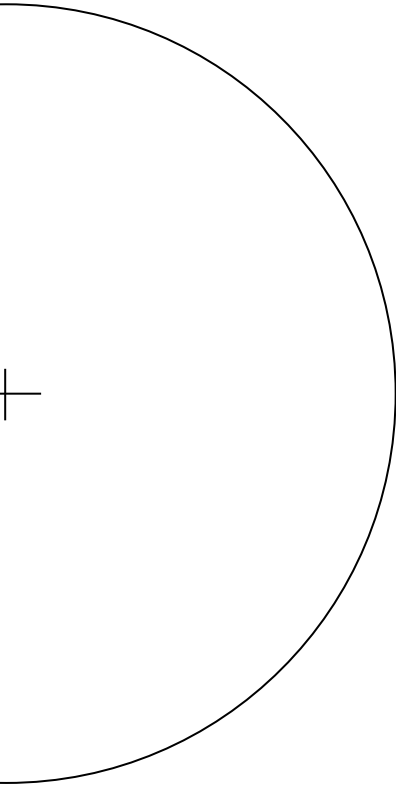

METAL DUCTWORK INSTALLATION (CONTINUED)

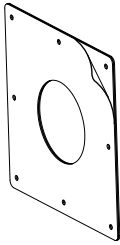

5. Remove backing from mounting plate adhesive gasket.

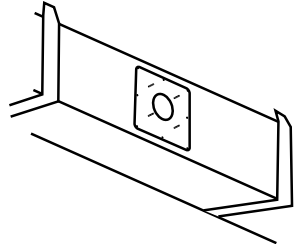

6. Center openings and press mounting plate onto duct. The adhesive gasket will hold the mounting plate in place.

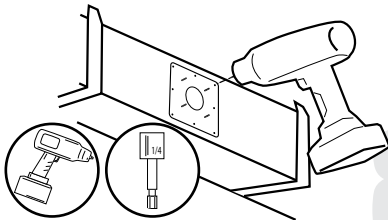

7. Secure the mounting plate using (8) #8 self-tapping screws.

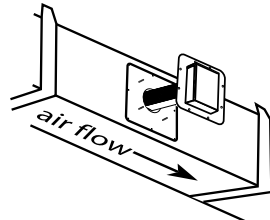

8. Insert unit into opening. Be sure the air will pass through the ActivePure cell honeycomb matrix.

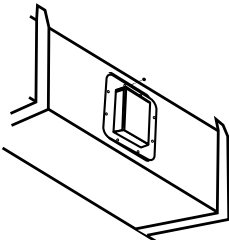

9. Secure the unit to the mounting plate with (4) #8-32 nuts.

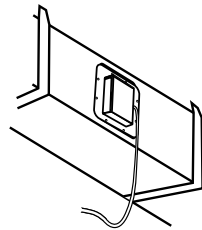

10. Plug unit into working power receptacle.



Hard wiring unit into HVAC system should be done by a licensed HVAC installer or electrical contractor only.

FIBERGLASS DUCTWORK INSTALLATION

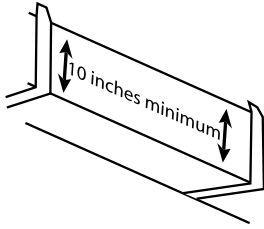

1. Locate suitable area of duct for installation.

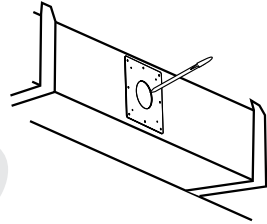

2. Mark location for 3.5" opening using either the mounting plate or included template. Also mark the locations of 4 screw holes in corners (see template).

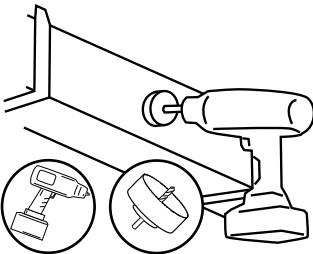

3. Cut hole in duct using 3.5" hole saw.

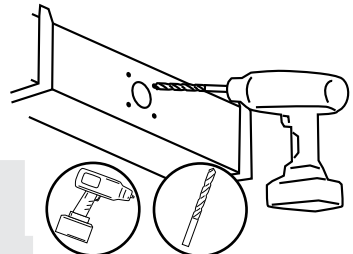

4. Drill 4 holes (at corner screw locations) using a 3/8" drill bit.

ALTERNATIVE CUTTING METHOD

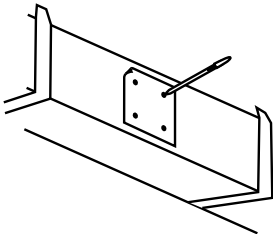

a. Using template, mark 4 holes on duct.

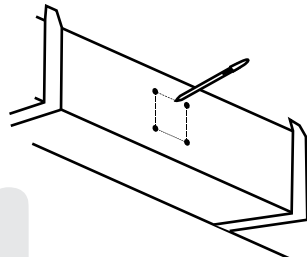

b. Draw a line between each corner mark.



c. Cut between holes using a utility knife. Continue with #4 (above)

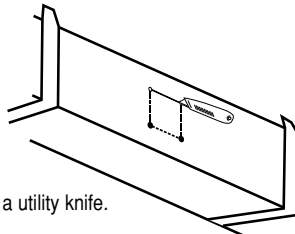

FIBERGLASS DUCTWORK INSTALLATION (CONTINUED)

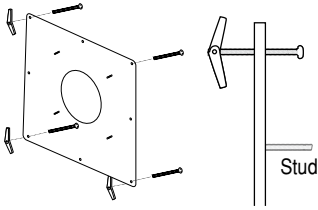

5. Insert (4) 2" Threaded bolts into screw holes at corners of mounting plate. Attach (4) toggle bolt anchors to ends of threaded bolts.

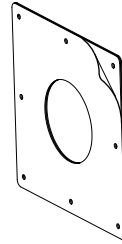

6. Remove backing from mounting plate adhesive gasket.

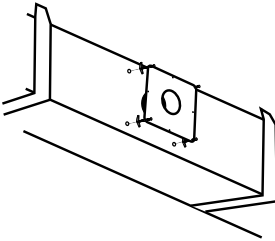

7. Insert (4) toggle bolts into 3/8" holes in duct. Be sure toggle anchors open after inserting.

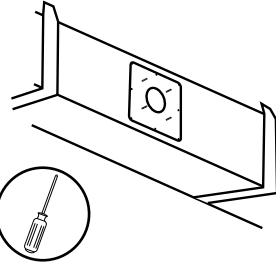

8. Center large opening in mounting plate over 3.5" opening in duct and press plate to duct. The adhesive gasket will hold the mounting plate into place. Tighten toggle bolts - DO NOT OVERTIGHTEN.

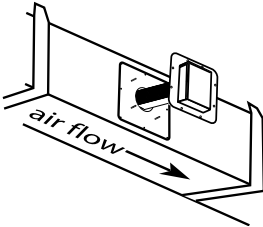

9. Insert unit into opening. Be sure the air will pass through the ActivePure cell honeycomb matrix.

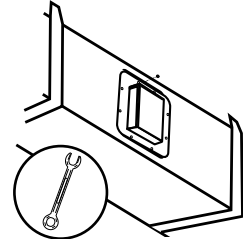

10. Secure the unit to the mounting plate with (4) #8-32 nuts.

11

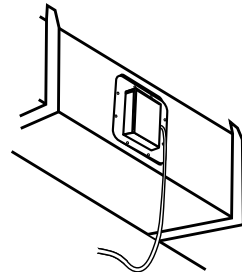

11. Plug unit into working power receptacle. Hard wiring unit into HVAC system should be done by a licensed HVAC installer or electrical contractor only.

MAINTENANCE/UV LAMP INDICATOR

Your activTek INDUCT 2000 unit requires no periodic maintenance beyond normal replacement of the ActivePure cell every 3 years.

Note: For optimal performance, activTek recommends the replacement of the ActivePure cell every 3 years, even if the UV lamp appears to be operating normally.

The UV lamp operation indicator on the face of the unit will glow when the UV lamp is in use. If the indicator does not glow and the unit has power, the ActivePure cell should be replaced.

UV lamp operation indicator

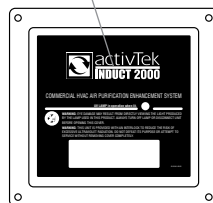

DISPOSAL OF THE ACTIVEPURE CELL

Please do not throw a used ActivePure cell into the garbage. The special germicidal UVX bulb used in the activTek INDUCT 2000 contains a very small amount of mercury. You may return your used ActivePure cell to activTek for proper disposal. Send the used cell post paid to:



activTek Environmental
ActivePure Disposal
55 Marley Drive
Greeneville, TN 37743

Did you forget to register your activTek INDUCT 2000?

By registering, you'll activate your warranty, and your privacy is guaranteed. Just fill out your warranty card and drop it in the mail.

WARRANTY INFORMATION

This product is of solid state construction and is under warranty by:

activTek Environmental
310 T. Elmer Cox Drive
Greeneville, TN 37743

to the original purchaser, depending on model, to be free from defect in materials and workmanship for a limited time. Length of warranty will vary depending on model. See warranty card for specific details. If you have any questions concerning your activTek INDUCT 2000, please see your local activTek Distributor.

For help, visit www.activTek.net.

CHANGING THE ACTIVEPURE CELL



WARNING! - UV Light in operation. Disconnect unit from power supply before servicing. Failure to follow warnings may result in severe eye damage.



1. Unplug unit. **If the unit is hard wired, be sure the power to the unit is off.**

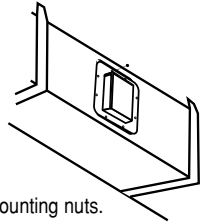

2. Remove the 4 mounting nuts.

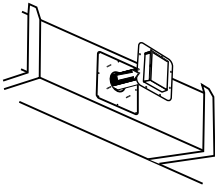

3. Remove the unit from the mounting plate.

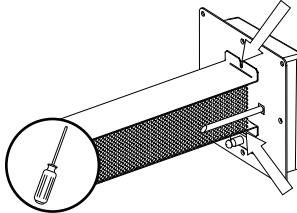

4. Remove the 2 screws holding the ActivePure Cell.

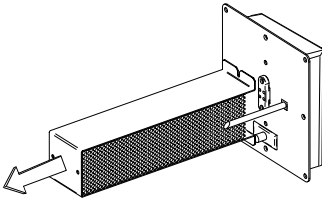

5. Separate the used ActivePure cell from the base unit and dispose of properly.

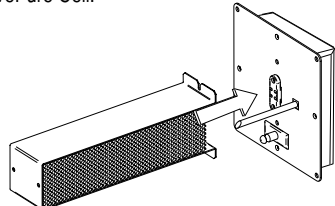

6. Plug the new ActivePure cell into the base unit.

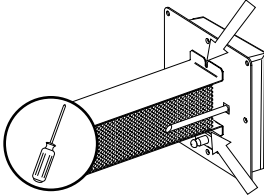

7. Secure with 2 screws.

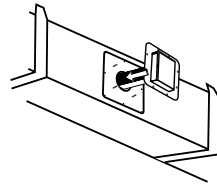

8. Insert the unit into the mounting plate.

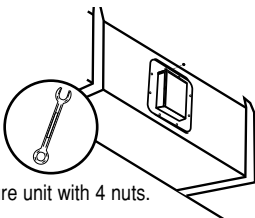

9. Secure unit with 4 nuts.

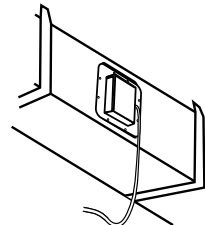

10. Reconnect power supply.